



2024 Price Pages





STONE AGE OUTDOOR LIVING KITS

MAKING CONSTRUCTION EASIER FOR OUTDOOR PROJECTS

REV: 02/01/24

TABLE OF CONTENTS

OUTDOOR FIREPLACE KITS

- Why Use a Stone Age Kit?..... 2
- Contractor Series 4
- Standard Series 5
- New Age Series 8



PIZZA OVEN KITS

- Mezzo/Amerigo 15



PIZZA OVEN / FIREPLACE COMBOS

- Mezzo Vent Free 16
- Caminetto Medeo & Grande 17



FIRE PIT KITS

- Short Round 20
- Tall Round 20
- Large Round 21
- Square/Rectangular 21

WHY USE STONE AGE OUTDOOR FIREPLACE KITS?



WHY USE AN OUTDOOR FIREPLACE KIT:

Outdoor Fireplace Kits make installing an outdoor fireplace faster and easier. Instead of spending hours or even days constructing the framework of an outdoor fireplace from scratch out of blocks, Stone Age Manufacturing kits arrive on a compact pallet and assemble in just 3-4 hours with the labor of only two people.

CUSTOMIZABLE

Adjust the height of your fireplace in a variety of ways or add wood storage boxes

- Install a custom base or hearth to the height you want. Use natural stone or other materials (risers and hearth included in Standard Series)
- Use a firebox extension to increase the height of your firebox
- Add flue extensions to reach desired height (check local codes for max height)
- Install a metal or stone chimney cap to finish the fireplace

Customize fireplace kits with accessories to reach the height you want.

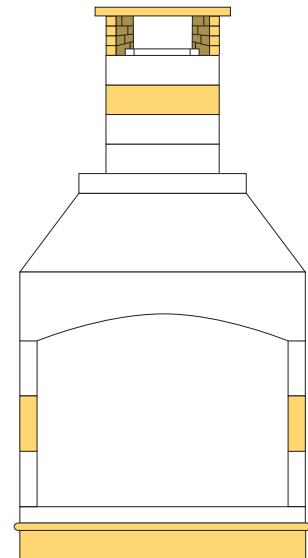

BENEFITS OF STONE AGE OUTDOOR FIREPLACE KITS

QUICK & EASY INSTALLATION

Once your concrete footing is ready, Stone Age kits require only 2 people to install in 3-4 hours and can be veneered the same day.



QUALITY CONSTRUCTION

Stone Age kits are solid construction, not hollow and are made from refractory cement reinforced with rebar.



PROPER DRAFT

Design takes the guesswork out of creating a proper draft and great fires. Larger flue keeps smoke flowing upward and not out of the front of the fireplace.

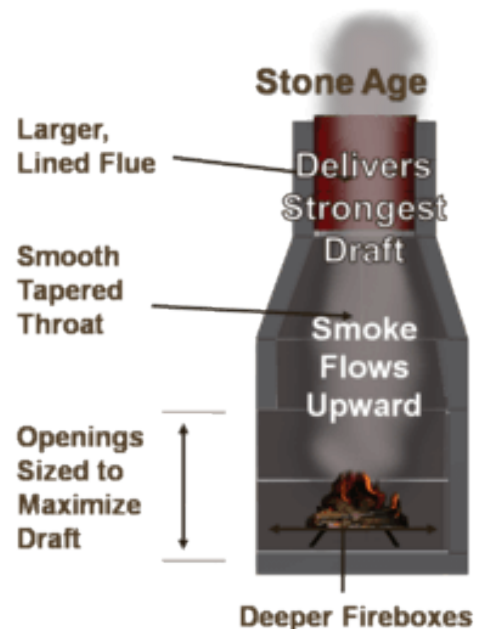

CONTRACTOR FIREPLACE SERIES

Traditional Style Base Kit



The Contractor Series offers Stone Age design and materials distilled down to its essential components of fireplace and chimney. Additional items are left optional to allow for full customization and the specific height requirements of your local regulations. **See page 6 for building necessities and accessories to customize height.** 24" Contractor Fireplace Kits available for special order, please call for details.



Overall Dimensions:
73.5"H x 46"W x 33"D
Weight: 1,250 lbs.

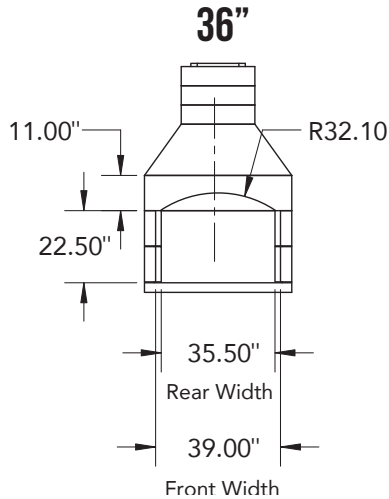

36" Contractor Kit

36" Contractor base kit, plus 3 flue extensions (6" each).
Firebrick not included. See finishing specs below.

\$3,012 Retail

Item #	Description	Lintel
SA-36CN	36" Contractor Kit	Arched
SA-36CN-SL	36" Contractor Kit	Straight
SA-36CN-SEETHRU	36" Contractor Kit - See-Thru	Arched
SA-36CN-SL-SEETHRU	36" Contractor Kit - See-Thru	Straight

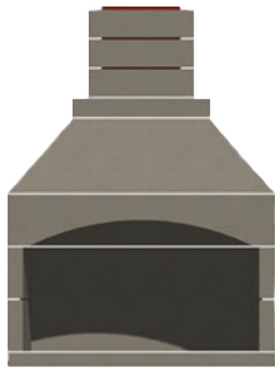

Overall Dimensions:
77.5"H x 58"W x 33"D
Weight: 1,490 lbs.

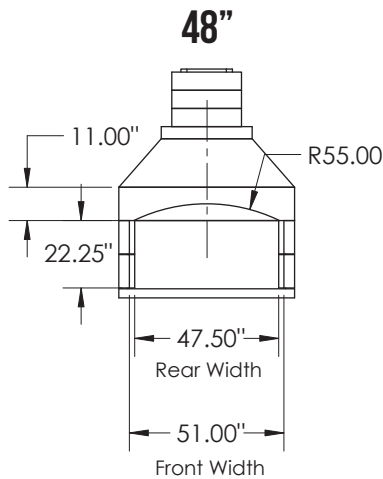

48" Contractor Kit

48" Contractor base kit, plus 3 flue extensions (6" each).
Firebrick not included. See finishing specs below.

\$3,648 Retail

Item #	Description	Lintel
SA-48CN	48" Contractor Kit	Arched
SA-48CN-SL	48" Contractor Kit	Straight
SA-48CN-SEETHRU	48" Contractor Kit - See-Thru	Arched
SA-48CN-SL-SEETHRU	48" Contractor Kit - See-Thru	Straight

NOTES:
Firebox widths are without Firebrick.

CURE TIME: For proper curing, please wait a minimum of 28 days before lighting any fires.
CONCRETE FOOTING REQUIRED — check local codes, but we recommend extending down to the frost line in your area.

SPECIFICATIONS

Finishing Requirements: Hi-Temp Mortar and firebrick splits required for assembly. See page 6 for item details.

Item #	Mortar for Assembly	Mortar for Veneer	Sq. Ft. of Veneer	Linear Ft of Veneer Corners	Firebrick Required
SA-36CN	4 Buckets (SA-APRM)	4 Buckets	85	26	85 splits (SA-SFB-WHT)
SA-36CN See-Thru	4 Buckets (SA-APRM)	4 Buckets	79	26	61 splits (SA-SFB-WHT)
SA-48CN	5 Buckets (SA-APRM)	5 Buckets	109	26	105 splits (SA-SFB-WHT)
SA-48CN See-Thru	5 Buckets (SA-APRM)	5 Buckets	101	26	73 splits (SA-SFB-WHT)

STANDARD FIREPLACE SERIES

Traditional Style Base Kit + Additional Pieces



The Standard Series Fireplace Kits includes:

- Contractor Base
- One (1) additional Flue Extension for a total of four (4)
- 18" Risers
- Hearth
- Firebrick

See page 6 for building necessities and accessories to customize height.

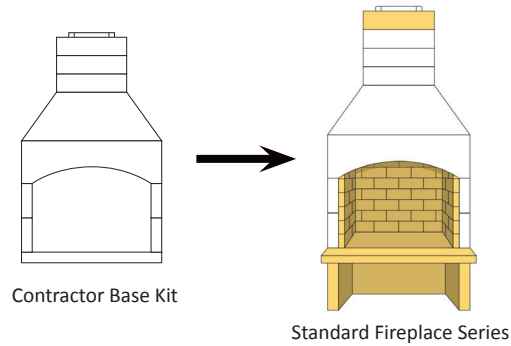

Overall Dimensions:
98.4"H x 46"W x 40"D
Weight: 2,190 lbs.

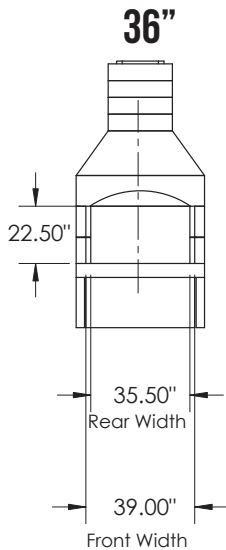

36" Standard Kit

36" Contractor base kit, plus 4 flue extensions (6" each), 18" risers and a hearth. Firebrick included. See finishing specs below.

\$4,615 Retail

Item #	Description	Lintel
SA-36STD	36" Standard Kit	Arched
SA-36STD-SL	36" Standard Kit	Straight
SA-36STD-SEETHRU	36" Standard Kit - See-Thru	Arched
SA-36STD-SL-SEETHRU	36" Standard Kit - See-Thru	Straight



Overall Dimensions:
102.75"H x 58"W x 40"D
Weight: 2,400 lbs.

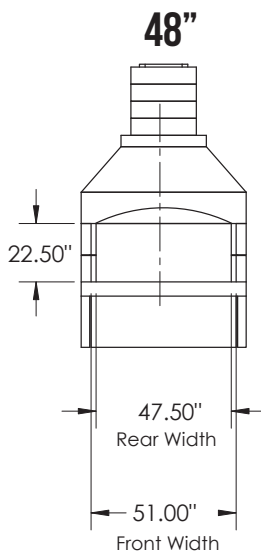

48" Standard Kit

48" Contractor base kit, plus 4 flue extensions (6" each), 18" risers and a hearth. Firebrick included. See finishing specs below.

\$5,575 Retail

Item #	Description	Lintel
SA-48STD	48" Standard Kit	Arched
SA-48STD-SL	48" Standard Kit	Straight

SPECIFICATIONS

Finishing Requirements: Hi-Temp Mortar required for assembly. See page 6 for item details.

Item #	Mortar for Assembly	Mortar for Veneer	Sq. Ft. of Veneer	Linear Ft of Veneer Corners	Firebrick Required
SA-36STD	4 Buckets (SA-APRM)	4 Buckets	100	32	Included
SA-36STD See-Thru	4 Buckets (SA-APRM)	4 Buckets	94	32	Included
SA-48STD	5 Buckets (SA-APRM)	5 Buckets	125	32	Included

STONE AGE BUILDING ESSENTIALS

Accessories



BUILDING NECESSITIES



Hi-Temp Mortar

SA-APRM*

5-gallon bucket covers 15-30 sq.ft.
Add 1 bucket per 8 additional flue extensions.

\$120 Retail

High temperature mortar required for assembly to maintain warranty. Ready-Mix, just add water.



Firebrick Splits

SA-SFB-WHT*

\$3.50/each Retail

1.25" Thick
Needed for fireplace firebox

ACCESSORIES TO ADD HEIGHT

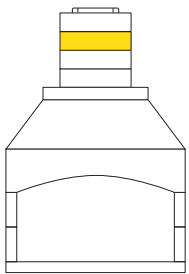

6" Flue Extensions
18" x 18" x 6"

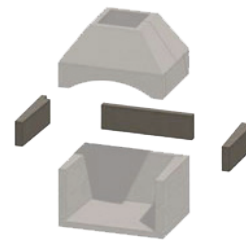
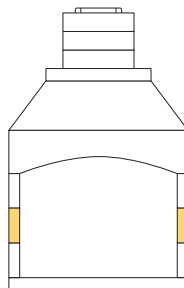

11.5" Firebox Extension

6" Flue Extensions

SA-FL-EXT*

Add 1 bucket of mortar per 8 additional flue extensions.
Add 4 sq. ft of veneer and 2 LF of corners per flue extension.

\$110 Retail

11.5" Firebox Extension

Item #	Description	Retail
SA-36-EXT	11.5" Firebox Extension for 36"	\$652
SA-48-EXT	11.5" Firebox Extension for 48"	\$764
SA-36-ST-EXT	11.5" Firebox Extension – 36" See-Thru	\$433
SA-48-ST-EXT*	11.5" Firebox Extension – 48" See-Thru	\$433

Firebox extensions require additional mortar (SA-APRM) and 40 split firebrick (SA-SFB-WHT) for the 36" and 46 split firebrick for the 48". 10 additional sq. ft of veneer will also be required for the 36", or 11 sq. ft. for the 48". 2 LF of corners are also required for each model.

WOOD STORAGE BOXES



Wood Storage Box

SA-WCA-K (Arched)
SA-WCS-K (Straight)

\$1,238 Retail

Dimensions: 36"H x 36"W x 33"D
Veneer: 27 sq. ft / 12 LF corners

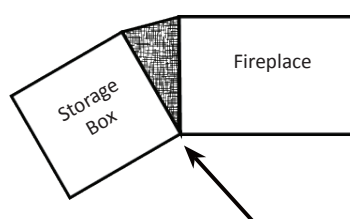

Angled Adapter for Wood Storage Box

SA-WAA-K

\$618 Retail

Adapter Kit Contains panels to finish area if angling wood storage box.

ADDITIONAL ACCESSORIES

Accessories



STAINLESS STEEL LOG GRATES



Stainless Steel Grates

H = Height | FW = Front Width | BW = Back Width | D = Depth

Item #	Description	H	FW	BW	D	Retail
18634	Grate	4"	25"	21"	16 1/4"	\$224
18635	Grate	4"	28"	25"	16 1/4"	\$269
18636	Grate	4"	32"	27"	16 1/4"	\$314

STAINLESS STEEL CHIMNEY CAPS



304 Stainless Steel Chimney Caps

Item #	Description	Fits Outside Tile Dimension	Retail
SS1313	13" X 13" Stainless Steel	11 1/2" x 11 1/2" to 13 1/2" x 13 1/2"	\$212
SS1318	13" X 18" Stainless Steel	11 1/2" x 16 1/2" to 13 1/4" x 18 1/4"	\$273
SS1818	18" X 18" Stainless Steel	16 1/2" x 16 1/2" to 18" x 18"	\$293

VENTED LOG SETS & ACCESSORIES

Please call to speak with your Empire Strategic Business Partner to discuss vented log sets and other fireplace accessories.



Warming Trends Fire Pit Burners



Wilderness Char Fire Pit Log Set



Wilderness Campfire Fire Pit Log Set

WHY CHOOSE A NEW AGE “ZERO CLEARANCE” FIREPLACE KIT



INDOOR

New Age fireplace kits are UL-127/ULC-S610 Certified for outdoor or indoor applications, and ICC-ES AC156 Certified for Seismic Resistance. Use a vented gas insert or wood burning.



MODERN LOOK

The flat top design of New Age Fireplace kits, not only gives a modern look, but also makes for easy construction and mounting televisions above fireplaces.



PAVILIONS AND PERGOLAS

The Zero Clearance rating for New Age kits means you can build directly onto the base kit, which means they build seamlessly and safely into backyard pavilions and pergolas.

BENEFITS OF NEW AGE SERIES FIREPLACE KITS



ZERO CLEARANCE

The design of New Age masonry chimneys incorporates the necessary “air gap” making it possible for framing to be in contact with the fireplace. A clay flue sits separately inside concrete outer blocks giving the fireplace its Zero Clearance rating.

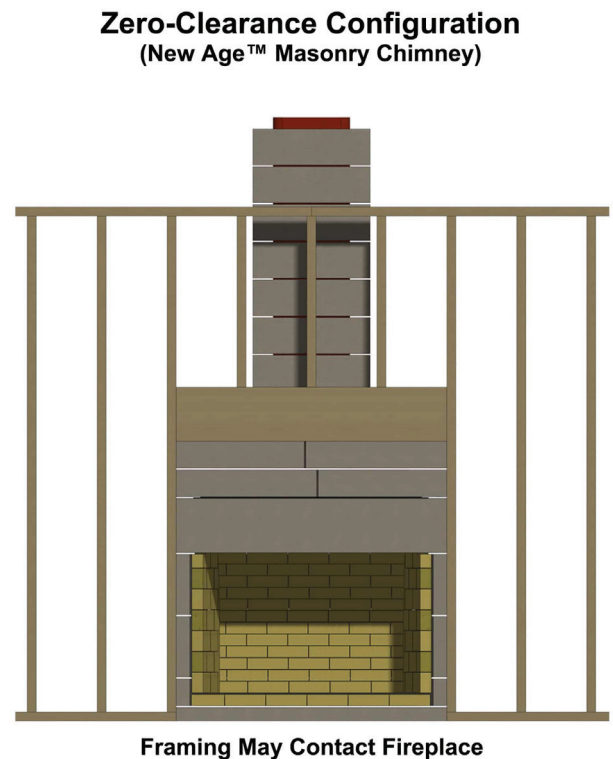
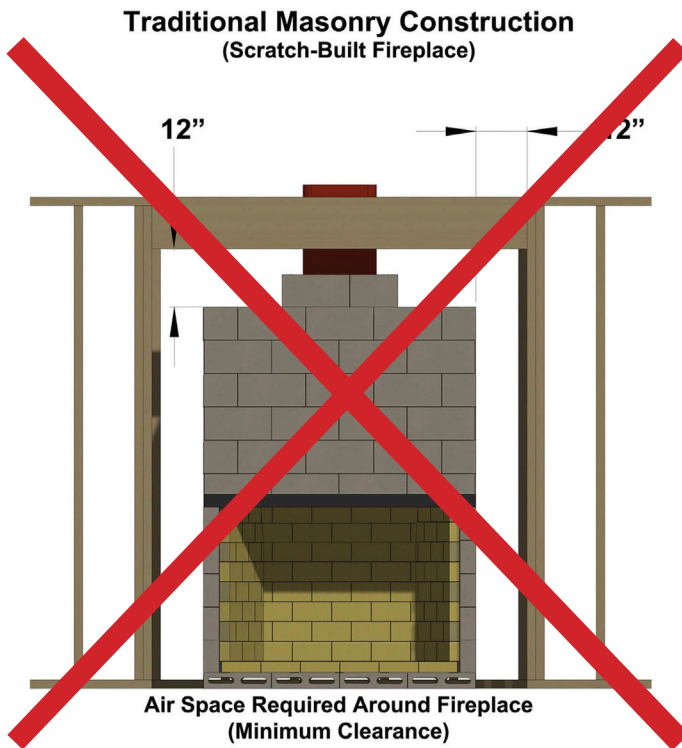

QUICK & EASY INSTALLATION

Once your concrete footing is ready, Stone Age kits require only 2 people to install in 3-4 hours and can be veneered the same day.

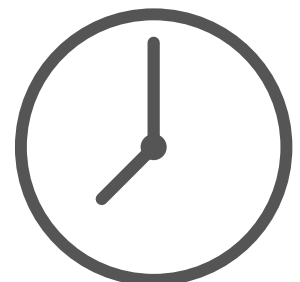

NEW AGE FIREPLACE SERIES

Zero-Clearance Rated Modern Fireplace



New Age fireplace kits are rated Zero-Clearance, meaning you can safely build right up to the chimney, which makes it great for mounting TVs. New Age kits can be installed using masonry chimneys or metal pipe.

See page 12-13 for building necessities, accessories and chimney information.



Overall Dimensions:
66.5"H x 54"W x 30"D
Weight: 2,050 lbs.

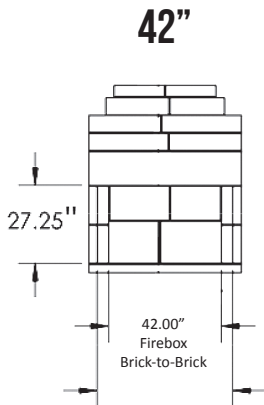

42" New Age Kit

42" New Age Kit. See finishing specs below.

\$3,677 Retail

Item #	Description	Retail
SA-NA-42	42" New Age Kit w/ Straight Lintel	\$3,677
SA-NA-ARCH-42	Arched Lintel	\$158
SA-2226-8	8" Flue Extension for 42" (22" x 26")	\$144
SA-FL1317*	Clay Flue Insert (13" x 17" x 24" can be cut)	\$105



Overall Dimensions:
72.5"H x 60"W x 30"D
Weight: 2,860 lbs.

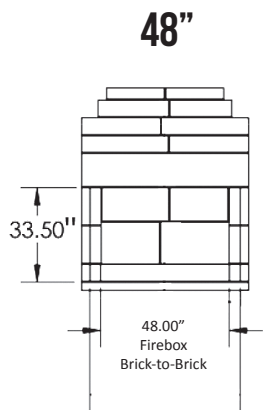

48" New Age Kit

48" New Age Kit. See finishing specs below.

\$4,053 Retail

Item #	Description	Retail
SA-NA-48	48" New Age Kit w/ Straight Lintel	\$4,053
SA-NA-ARCH-48	Arched Lintel	\$158
SA-2226-8	8" Flue Extension for 42" (22" x 26")	\$144
SA-FL1317*	Clay Flue Insert (13" x 17" x 24" can be cut)	\$105

NOTES:

Finishing specs refer to OUTDOOR installations only. For interior installations, where the back of the fireplace will be against a wall, less veneer will be required. Fireplace size is firebox measured from brick to brick. New Age models use full brick.

CURE TIME: For proper curing, please wait a minimum of 28 days before lighting any fires. CONCRETE FOOTING REQUIRED — check local codes, but we recommend extending down to the frost line in your area.

SPECIFICATIONS

Finishing Requirements: Hi-Temp Mortar and full Firebrick required for assembly. See page 13 for item details.

Item #	Mortar for Assembly	Mortar for Veneer	Sq. Ft. of Veneer	Linear Ft of Veneer Corners	Firebrick Required
SA-NA-42	6 Buckets (SA-APRM)	5 Buckets	105	32	120 full (SA-FFB-WHT)
SA-NA-48	7 Buckets (SA-APRM)	6 Buckets	115	34	150 full (SA-FFB-WHT)

NEW AGE FIREPLACE SERIES

Zero-Clearance Rated Modern Fireplace



New Age fireplace kits are rated Zero-Clearance, meaning you can safely build right up to the chimney, which makes it great for mounting TVs. New Age kits can be installed using masonry chimneys or metal pipe.

See page 12-13 for building necessities, accessories and chimney information.



Overall Dimensions:
85"H x 72"W x 30"D
Weight: 3,900 lbs.

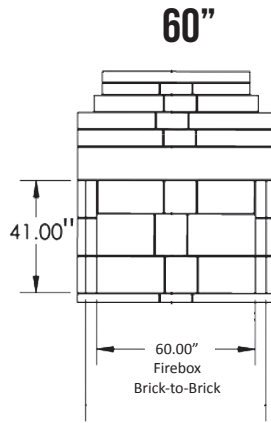

60" New Age Kit

60" New Age Kit - Requires double chimney stack.
Arched lintel not available. See finishing specs below.

\$6,031 Retail

Item #	Description	Retail
SA-NA-60	60" New Age Kit w/ Straight Lintel	\$6,031
SA-2323-8	8" Flue Extension for 60" (23" x 23")	\$137
SA-FL1313*	Clay Flue Insert (13" x 13" x 24" can be cut)	\$55



Overall Dimensions:
85"H x 84"W x 30"D
Weight: 4,900 lbs.

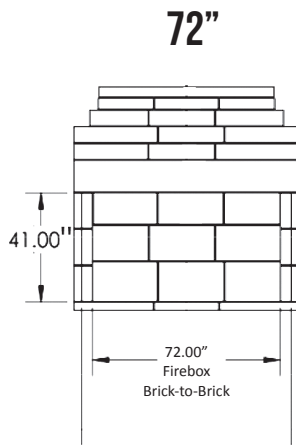

72" New Age Kit

72" New Age Kit - Requires double chimney stack.
Arched lintel not available. See finishing specs below.

\$6,935 Retail

Item #	Description	Retail
SA-NA-72	72" New Age Kit w/ Straight Lintel	\$6,935
SA-2226-8	8" Flue Extension for 72" (22" x 26")	\$144
SA-FL1317*	Clay Flue Insert (13" x 17" x 24" can be cut)	\$105

NOTES:

Finishing specs refer to OUTDOOR installations only. For interior installations, where the back of the fireplace will be against a wall, less veneer will be required. Fireplace size is firebox measured from brick to brick. New Age models use full brick.

CURE TIME: For proper curing, please wait a minimum of 28 days before lighting any fires. CONCRETE FOOTING REQUIRED — check local codes, but we recommend extending down to the frost line in your area.

SPECIFICATIONS

Finishing Requirements: Hi-Temp Mortar and full Firebrick required for assembly. See page 13 for item details.

Item #	Mortar for Assembly	Mortar for Veneer	Sq. Ft. of Veneer	Linear Ft of Veneer Corners	Firebrick Required
SA-NA-60	8 Buckets (SA-APRM)	7 Buckets	140	36	175 full (SA-FFB-WHT)
SA-NA-72	9 Buckets (SA-APRM)	8 Buckets	165	36	200 full (SA-FFB-WHT)

NEW AGE FIREPLACE SERIES

Chimney Construction



MASONRY CHIMNEY

New Age™ kits are available in all-masonry, zero clearance configurations, where structural framing may be placed in direct contact with the kit and its masonry chimney. A separate clay flue sits within the concrete outdoor block to create an “air gap” necessary for Zero Clearance applications. Larger fireplaces (60”, 72”) require double chimney stacks.

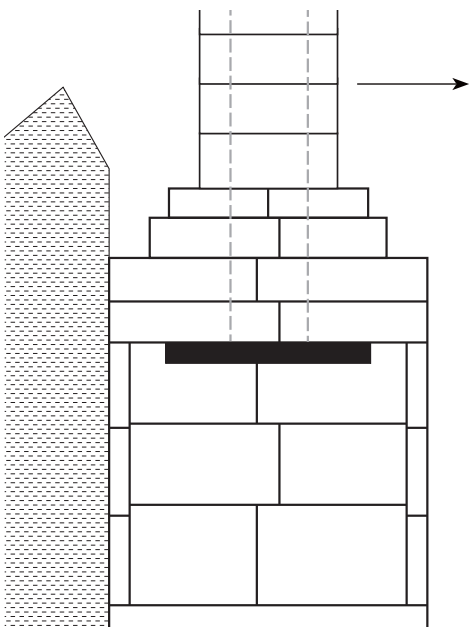

Air Gap



8” Flue Extension Outer Blocks

Add 1 bucket of mortar per 8 additional flue extensions.



Clay Flue

Item #	Description	Retail
SA-2323-8	23” x 23” x 8” Outer Block (for 60”)	\$137
SA-FL1313*	13” x 13” x 24” Clay Flue (for 60”)	\$55
SA-2226-8	22” x 26” x 8” Outer Block (for 42”, 48”, 72”)	\$144
SA-FL1317*	13” x 17” x 24” Clay Flue (for 42”, 48”, 72”)	\$105

METAL PIPE CHIMNEY

New Age™ kits may be used with 14” or 16” UL-103 metal chimney flue. However, please note that unlike our masonry flue, the metal pipe will need a 2” clearance from combustibles. Metal pipe is ideal in situations where total weight could become an issue and is around 10x faster to install vs. a masonry flue. Larger fireplaces (60”, 72”) require double pipes for flue.

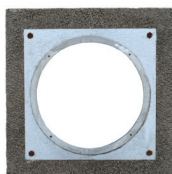
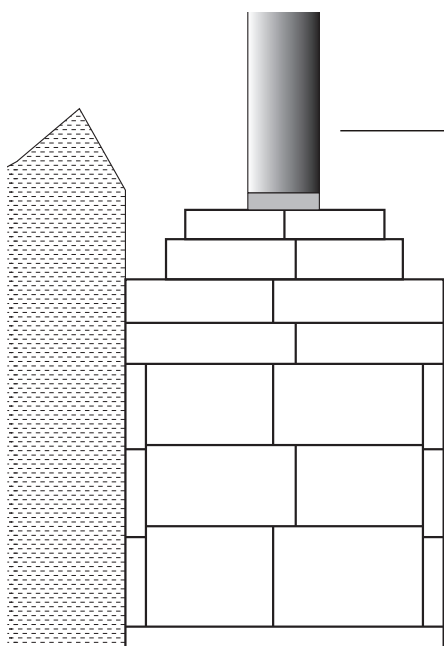

Pipe Adaptor

For Metal Pipe flue installations 14” or 16”



- New Age 42” = 16” Diameter**
- New Age 48” = 16” Diameter**
- New Age 60” = 14” Diameter x 2**
- New Age 72” = 16” Diameter x 2**

Call to speak with your Empire Strategic Business Partner to discuss metal pipe flue installations.

NEW AGE FIREPLACE SERIES

Accessories



BUILDING NECESSITIES



Hi-Temp Mortar

SA-APRM*

5-gallon bucket covers 15-30 sq.ft.
Add 1 bucket per 8 additional flue extensions.

\$120 Retail

High temperature mortar required for assembly to maintain warranty. Ready-Mix, just add water.



Full Firebrick

SA-FFB-WHT*

\$3.75/each Retail

2.5" Thick
Needed for fireplace firebox, not included with kit.

WOOD STORAGE BOXES



Wood Storage Box

SA-WCA-NA-K (Arched)
SA-WCS-NA-K (Straight)

\$1,238 Retail

Dimensions: 36"H x 36"W x 30"D
Veneer: 27 sq. ft / 12 LF corners

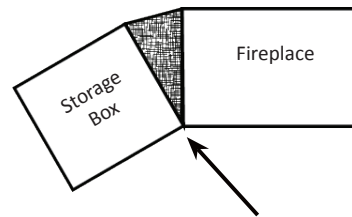

Angled Adapter for Wood Storage Box

SA-WAA-NA-K

\$618 Retail

Adapter Kit Contains panels to finish area if angling wood storage box.

STAINLESS STEEL LOG GRATES

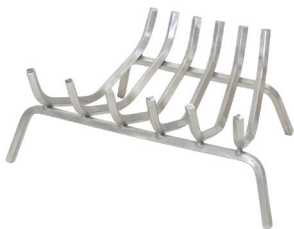

Stainless Steel Grates

H = Height | FW = Front Width | BW = Back Width | D = Depth

Item #	Description	H	FW	BW	D	Retail
18634	Grate	4"	25"	21"	16 ¼"	\$224
18635	Grate	4"	28"	25"	16 ¼"	\$269
18636	Grate	4"	32"	27"	16 ¼"	\$314

STAINLESS STEEL CHIMNEY CAPS



304 Stainless Steel Chimney Caps

Item #	Description	Fits Outside Tile Dimension	Retail
SS1313	13" X 13" Stainless Steel	11 ½" x 11 ½" to 13 ½" x 13 ½"	\$212
SS1318	13" X 18" Stainless Steel	11 ½" x 16 ½" to 13 ¼" x 18 ¼"	\$273
SS1818	18" X 18" Stainless Steel	16 ½" x 16 ½" to 18" x 18"	\$293

OUTDOOR PIZZA OVEN KITS

Traditional Wood-Fired Pizzas



MEZZO

Mezzo kits have 800 square inches of cooking space but can reach up to 800° for perfect, super-fast pizzas.



AMERIGO

Amerigo kits boast 1,500 square inches of cooking space. Great for parties or businesses.



KITCHENS

Pizza oven kits make outdoor kitchens better. Ask about Stone Age's Panel & Bracket Masonry Kitchen base system.



WOOD FIRED PIZZA

Ovens reach up to 800° and can cook a pizza in 90 seconds. Authentic wood-fired pizza right in your backyard.

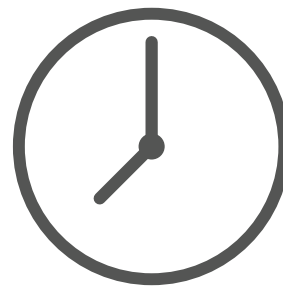

QUICK INSTALLATION

Once your concrete footing is ready, Stone Age kits require only 2 people to install in 3-4 hours and can be veneered the same day.

OUTDOOR PIZZA OVEN KITS

Traditional Wood-Fired Pizzas



Stone Age Outdoor Pizza Oven Kits are designed for optimum heat retention, with temperatures reaching up to 800°. Two sizes are available. Wood Storage boxes are sold separately.

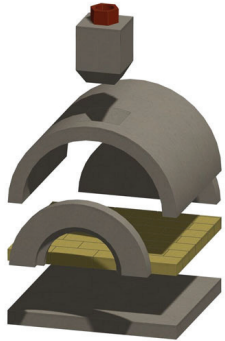

Overall Dimensions:
36" H x 36" W x 33" D
Dome Height: 23.5"
Cooking Surface: 800 Sq. In.
Weight: 750 lbs.

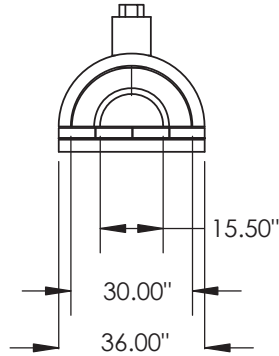

Mezzo Pizza Oven

Metal door and firebrick included. See finishing specs below.

\$3,181 Retail

Item #	Description	Retail
SA-MPO-36	Mezzo Pizza Oven	\$3,181
SA-MCA-36-K	Pizza Oven Wood Storage Box - Mezzo Arched	\$1,238
SA-MCS-36-K	Pizza Oven Wood Storage Box - Mezzo Straight	\$1,238
SA-FLAPO*	Pizza Oven 12" Chimney Extension (not tapered)	\$98

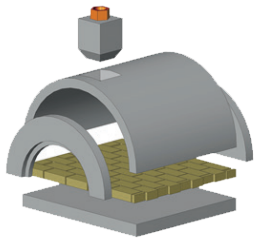

Overall Dimensions:
42.5" H x 48" W x 42" D
Dome Height: 30"
Cooking Surface: 1,500 Sq. In.
Weight: 1,230 lbs.

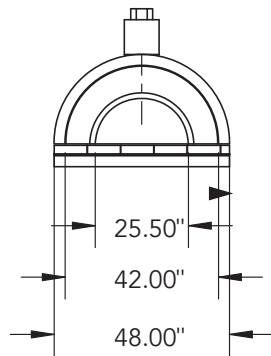

Amerigo Pizza Oven

Larger model. Metal door and firebrick included. See finishing specs below.

\$3,949 Retail

Item #	Description	Retail
SA-APO-48	Amerigo Pizza Oven	\$3,949
SA-PCA-48-K	Pizza Oven Wood Storage Box - Amerigo Arched	\$1,480
SA-APO48-BPE*	Pizza Oven Base Plate Extension	\$376
SA-APO48-ATWC*	Access Tunnel with Chimney	\$928
SA-FLAPO*	Pizza Oven 12" Chimney Extension (not tapered)	\$98

NOTES: Temperatures reach up to 800°

CURE TIME: For proper curing, please wait a minimum of 28 days before lighting any fires.

CONCRETE FOOTING REQUIRED — check local codes, but we recommend extending down to the frost line in your area.

ACCESSORIES



High temperature mortar needed for joints

SA-APRM*
\$120

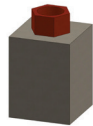

Pizza Oven 12" Chimney Extension
9.5" L x 12" H x 9.5" D

SA-FLAPO*
\$98



Amerigo Access Tunnel

SA-APO48-ATWC*
\$928

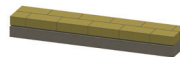

Amerigo Base Plate Extension

SA-APO48-BPE*
\$376

WOOD STORAGE BOX SPECS

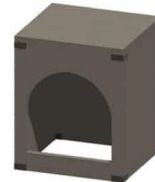

Mezzo:
SA-MCA-36-K (Arched)
SA-MCS-36-K (Straight)
Dimensions: 44" H x 36" W x 33" D
Veneer: 25 sq. ft / 16 LF corners

Amerigo:
SA-PCA-36-K (Arched)
Dimensions: 44" H x 48" W by 33" D
Veneer: 42 sq. ft / 16 LF corners

SPECIFICATIONS

Finishing Requirements: Hi-Temp Mortar required for assembly.

Item #	Mortar for Assembly	Mortar for Veneer	Sq. Ft. of Veneer	Linear Ft of Veneer Corners	Firebrick Required
SA-MPO-36	2 Buckets (SA-APRM)	1-2 Buckets	25	14	Included
SA-APO-48	3 Buckets (SA-APRM)	2 Buckets	35	14	Included

FIREPLACE / PIZZA OVEN COMBOS

Gas Insert Only



Stone Age Fireplace and Pizza Oven Combo Kits offer the best of both worlds. Soothing fire and heat when you want it, and pizza in the same structure.



Overall Dimensions:
75"H x 46"W x 42"D
(33"D without pizza shelf)
Dome Height: 23.5"
Firebox Width: 36"
Cooking Surface: 800 Sq. In.
Weight: 3,306 lbs.

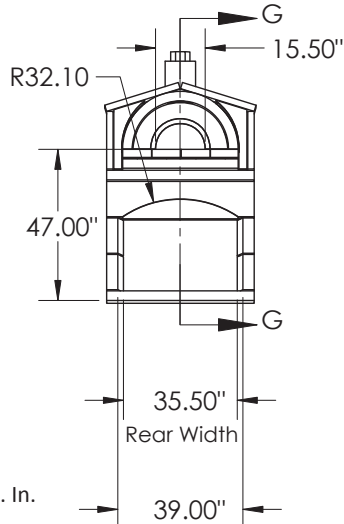

Mezzo Vent Free

Metal door and firebrick included. Gas insert only. See finishing specs below.

\$6,596 Retail

Item #	Description	Retail
SA-MPO-VFC	Mezzo Vent Free Combo	\$6,596
SA-MCA-36-K	Pizza Oven Wood Storage Box - Mezzo Arched	\$1,238
SA-MCS-36-K	Pizza Oven Wood Storage Box - Mezzo Straight	\$1,238
SA-FLAPO*	Pizza Oven 12" Chimney Extension (not tapered)	\$98

VENT LESS GAS INSERT

Complete the fireplace portion of your Mezzo Vent Free with a log set and burner.

Item #	Description	Retail
LMF24GTA	Giant Timbers 24" VF Logs, Concrete (1 of 2)	\$219
LMF24GTB	Giant Timbers 24" VF Logs, Concrete (2 of 2)	\$219
MNF24ONE	24" Electronic, VF Ember Bed Stainless Burner, with Variable Remote - NG	\$1,959
MNF24OPE	24" Electronic, VF Ember Bed Stainless Burner, with Variable Remote - LP	\$1,959



Giant Timbers, Concrete

MEZZO VENT FREE ACCESSORIES



High temperature mortar needed for joints

SA-APRM*
\$120

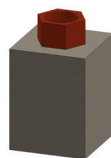

Pizza Oven 12" Chimney Extension
9.5"L x 12"H x 9.5"D

SA-FLAPO*
\$98

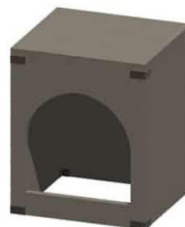

Wood Storage Box

SA-MCA-36-K (Arched)
SA-MCA-36-K (Straight)

\$1,238 Retail

Dimensions: 44"H x 36"W x 33"D
Veneer: 25 sq. ft / 16 LF corners

SPECIFICATIONS

Finishing Requirements: Hi-Temp Mortar required for assembly.

Item #	Mortar for Assembly	Mortar for Veneer	Sq. Ft. of Veneer	Linear Ft of Veneer Corners	Firebrick Required
SA-MPO-VFC	5 Buckets (SA-APRM)	5 Buckets	67	24	Included

OUTDOOR FIREPLACE / PIZZA OVEN COMBOS

Wood Burning or Gas Insert



The Caminetto models are based on the Mezzo Pizza Oven and New Age Fireplaces bases. Fire or Pizza or both in one structure.

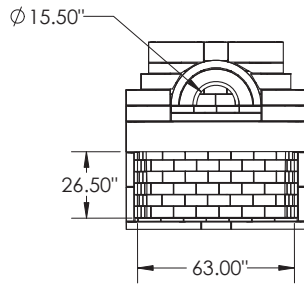
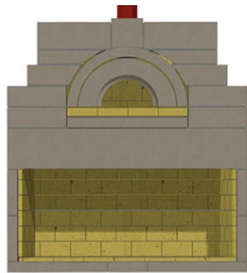

Overall Dimensions:
82"H x 72"W x 30"D
Dome Height: 23.5"
Firebox Width: 63"
Cooking Surface: 600 Sq. In.
Weight: 6,006 lbs.

Caminetto Medeo

Includes firebrick and metal oven door. Requires a double chimney stack, plus pizza oven chimney extensions to extend the chimney height. See finishing specs below.

\$10,178 Retail

Item #	Description	Retail
SA-CMO-63	Caminetto Medeo Combo	\$10,178
SA-2323-8	8" Flue Extension for Medeo (23" x 23")	\$137
SA-FL1313*	Clay Flue Insert (13" x 13" x 24" can be cut)	\$55
SA-FLAPO*	Pizza Oven 12" Chimney Extension (not tapered)	\$98

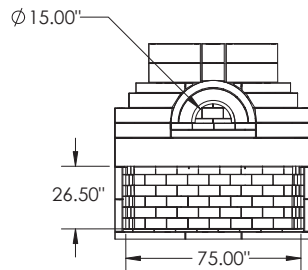
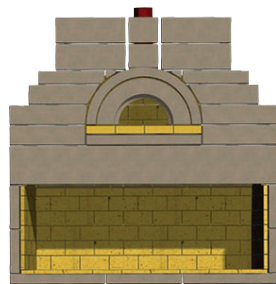

Overall Dimensions:
83.5"H x 84"W x 30"D
Dome height: 23.5"
Firebox Width: 75"
Cooking Surface: 600 Sq. In.
Weight: 7,114 lbs.

Caminetto Grande

Includes firebrick and metal oven door. Requires a double chimney stack, plus pizza oven chimney extensions to extend the chimney height. See finishing specs below.

\$11,270 Retail

Item #	Description	Retail
SA-CGO-75	Caminetto Grande Combo	\$11,270
SA-2226-8	8" Flue Extension for 72" (22" x 26")	\$144
SA-FL1317*	Clay Flue Insert (13" x 17" x 24" can be cut)	\$105
SA-FLAPO*	Pizza Oven 12" Chimney Extension (not tapered)	\$98

NOTES:

Temperatures reach up to 800°

CURE TIME: For proper curing, please wait a minimum of 28 days before lighting any fires. **CONCRETE FOOTING REQUIRED** — check local codes, but we recommend extending down to the frost line in your area.

SPECIFICATIONS

Finishing Requirements: Hi-Temp Mortar required for assembly. See page 18 for item details.

Item #	Mortar for Assembly	Mortar for Veneer	Sq. Ft. of Veneer	Linear Ft of Veneer Corners	Firebrick Required
SA-CMO-63	8 Buckets (SA-APRM)	8 Buckets	140	36	Included
SA-CGO-75	9 Buckets (SA-APRM)	9 Buckets	165	36	Included

FIREPLACE / PIZZA OVEN COMBOS

Accessories



BUILDING NECESSITIES



Hi-Temp Mortar

SA-APRM*

5-gallon bucket covers 15-30 sq.ft.
Add 1 bucket per 8 additional flue extensions.

\$120 Retail

High temperature mortar required for assembly to maintain warranty. Ready-Mix, just add water.

ACCESSORIES TO ADD HEIGHT

To achieve Zero Clearance rating, New Age fireplaces use full firebrick and a chimney system consisting of cement outer blocks and separate clay flues with an "air gap" between them. New Age fireplaces can also be installed with metal chimney pipes, but require a metal pipe adaptor. Larger New Age models require double chimney stacks.



8" Flue Extension Outer Blocks

Add 1 bucket of mortar per 8 additional flue extensions.
Add 6 sq. ft. of veneer and 2 LF of corners per flue extension.



Clay Flue

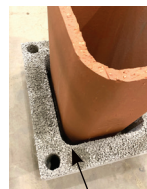

Air Gap

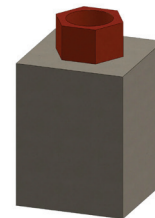

Pizza Oven 12" Chimney Extension

SA-FLAPO*

9.5"L x 12"H x 9.5"D

\$98 Retail

Item #	Description	Retail
SA-2323-8	23" x 23" x 8" Outer Block (for 60")	\$137
SA-FL1313*	13" x 13" x 24" Clay Flue (for 60")	\$55
SA-2226-8	22" x 26" x 8" Outer Block (for 42", 48", 72")	\$144
SA-FL1317*	13" x 17" x 24" Clay Flue (for 42", 48", 72")	\$105

CAMINETTO WOOD STORAGE BOXES



Wood Storage Box

SA-WCA-NA-K (Arched)

SA-WCS-NA-K (Straight)

\$1,238 Retail

Dimensions: 36"H x 36"W x 30"D
Veneer: 27 sq. ft / 12 LF corners

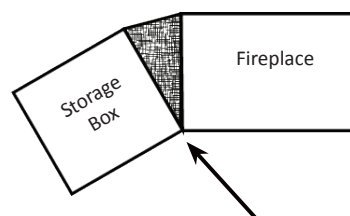

Angled Adapter for Wood Storage Box

SA-WAA-NA-K

\$618 Retail

Adapter Kit Contains panels to finish area if angling Wood Storage

FIRE PIT KITS

Wood Burning or Gas Insert



WOOD BURNING

Choose wood burning for the crackle and smell of wood fires.



QUICK INSTALLATION

Once your concrete footing is ready, Stone Age kits require only 2 people to install in 1-2 hours and can be veneered the same day. Full firebrick is recommended for safety, but split firebrick can be used.

GAS INSERT

Install a gas burner or decorative log set for easy fire on demand.

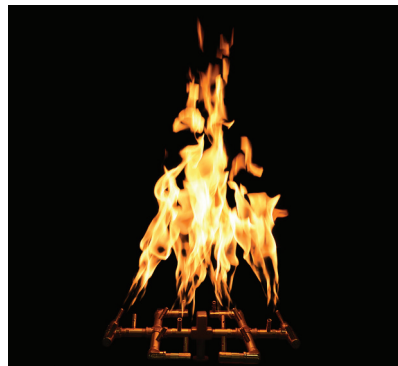

WARMING TRENDS

Ask about Warming Trends burner and plate kits to make installing gas inserts easy.

FIRE PIT KITS

Wood Burning or Gas Insert



Stone Age Fire Pit Kits provide an easily installed base for fire pits. They can be installed as wood burning or with gas inserts. Full firebrick recommended.

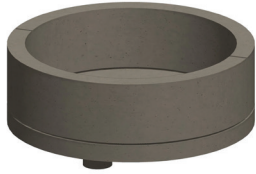

Overall Height: 14"
Height with Feet: 16.5"
Diameter: 36"
Weight: 400 lbs.

Short Round

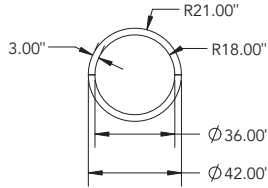

Short Round Fire Pit Kit

Full firebrick recommended (not included). See finishing specs below.

\$860 Retail

Item #	Description	Retail
SA-SRP	Short Round Fire Pit (36" diameter)	\$860

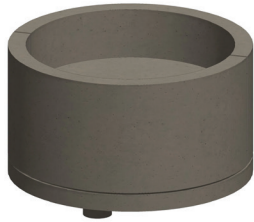

Overall Height: 25"
Height with Feet: 27"
Diameter: 36"
Weight: 620 lbs.

Tall Round

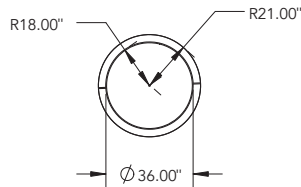

Tall Round Fire Pit Kit

Full firebrick recommended (not included). See finishing specs below.

\$1,145 Retail

Item #	Description	Retail
SA-TRP	Tall Round Fire Pit (36" diameter)	\$1,145

NOTES: Firebrick not included. Full firebrick recommended but not required. Feet come attached to the base but can be removed for flat installation.
CURE TIME: For proper curing, please wait a minimum of 28 days before lighting any fires.

Check local codes before installing any fire features.

BUILDING NECESSITIES



Hi-Temp Mortar SA-APRM*

5-gallon bucket covers 15-30 sq.ft.
 Add 1 bucket per 8 additional flue extensions.

\$120 Retail

High temperature mortar required for assembly to maintain warranty. Ready-Mix, just add water.



Full Firebrick SA-FFB-WHT*

\$3.75/each Retail

2.5" Thick (Recommended)



Firebrick Splits SA-SFB-WHT*

\$3.50/each Retail

1.25" Thick (Can be used)

SPECIFICATIONS

Finishing Requirements: Hi-Temp Mortar and Firebrick required for assembly.

Item #	Mortar for Assembly	Mortar for Veneer	Sq. Ft. of Veneer	Linear Ft of Veneer Coping	Firebrick Required
SA-SRP	2 Buckets (SA-APRM)	1 Buckets	15	11	51 full (SA-FFB-WHT)
SA-TRP	2 Buckets (SA-APRM)	1 Buckets	25	11	74 full (SA-FFB-WHT)

FIRE PIT KITS

Wood Burning or Gas Insert



Stone Age Fire Pit Kits provide an easily installed base for fire pits. They can be installed as wood burning or with gas inserts. Full firebrick recommended.

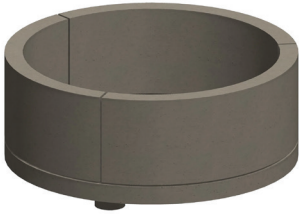

Overall Height: 18"
Height with Feet: 20.5"
Diameter: 42"
Weight: 525 lbs.

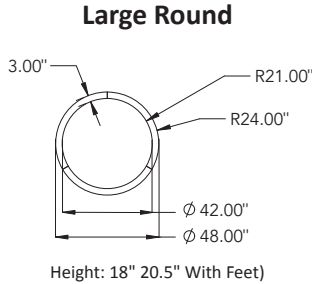

Large Round Fire Pit Kit

Full firebrick recommended (not included). See finishing specs below.

\$1,145 Retail

Item #	Description	Retail
SA-LRP	Large Round Fire Pit (42" diameter)	\$1,145



Overall Dimensions:
15"H x 36"W x 36"D
Height with Feet: 17"
Weight: 525 lbs.

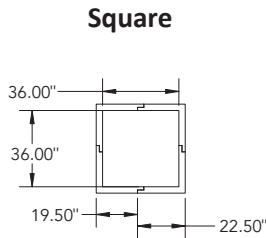

Square Fire Pit Kit

Full firebrick recommended (not included). See finishing specs below.

\$999 Retail

Item #	Description	Retail
SA-SQP	Square Fire Pit (36" diameter)	\$999
SA-SQP-EXT	Rectangular Extension w/ Floor Piece (adds 12")	\$141

With Rectangular Extension (includes base)

Overall Dimensions:
15"H x 48"W x 36"D
Height with Feet: 17"
Weight: 625 lbs.

NOTES: Firebrick not included. Full firebrick recommended but not required.

Feet come attached to the base but can be removed for flat installation.

CURE TIME: For proper curing, please wait a minimum of 28 days before lighting any fires.

Check local codes before installing any fire features.

ACCESSORIES



Glacier Bay Natural Stone Fire Pit Caps

Item #	Description	Retail
FPCAP-SRP-GB	Fire Pit Cap - Short and Tall Round	\$699
FPCAP-LRP-GB	Fire Pit Cap - Large Round	\$799
FPCAP-VAL-GB	Fire Pit Cap - Techo Valencia	\$699

SPECIFICATIONS

Finishing Requirements: Hi-Temp Mortar and Firebrick required for assembly. See page 20 for item details.

Item #	Mortar for Assembly	Mortar for Veneer	Sq. Ft. of Veneer	Linear Ft of Veneer Coping	Firebrick Required
SA-LRP	2 Buckets (SA-APRM)	1 Bucket	25	11	76 full (SA-FFB-WHT)
SA-SQP	2 Buckets (SA-APRM)	1 Bucket	20 (5 corners)	14	73 full (SA-FFB-WHT)
SA-SQP-EXT	1 Bucket (SA-APRM)	1 Bucket	2	2	19 full (SA-FFB-WHT)



CONTACT US

NEW ENGLAND

SALES

Coming Soon

Sales@empiredistributing.net
716-870-2096

CUSTOMER SERVICE

Alba Plasencia-Molina

Alba@empiredistributing.net
585-736-4045

DELAWARE, MARYLAND & VIRGINIA

SALES

Wayne Dean

WDean@empiredistributing.net
716-860-0196

CUSTOMER SERVICE

Juanita Wolfe

Juanita@empiredistributing.net
585-736-4044

LONG ISLAND

SALES

Mike Rupp

Mike@empiredistributing.net
716-860-0206

CUSTOMER SERVICE

Dawn Dahlke

Dawn@empiredistributing.net
585-736-4055

UPSTATE NEW YORK NORTHWEST PENNSYLVANIA

SALES

Chuck Wander

ChuckW@empiredistributing.net
716-475-8467

CUSTOMER SERVICE

Dawn Dahlke

Dawn@empiredistributing.net
585-736-4055

WESTERN NEW YORK

SALES

Jason Rupp

Jason@empiredistributing.net
716-432-0773

CUSTOMER SERVICE

Dawn Dahlke

Dawn@empiredistributing.net
585-736-4055

NEW JERSEY EASTERN PENNSYLVANIA

SALES

Dan Davison

Dan@empiredistributing.net
716-860-1707

CUSTOMER SERVICE

Alba Plasencia-Molina

Alba@empiredistributing.net
585-736-4045

SOUTHWEST PENNSYLVANIA

SALES

Katherine Ahrens

KatherineA@empiredistributing.net
716-860-3034

CUSTOMER SERVICE

Dawn Dahlke

Dawn@empiredistributing.net
585-736-4055

ACCOUNTING

*New York & Long Island
Western Pennsylvania*

Cassandra Lydell

Cassandra@empiredistributing.net
585-736-4041

ACCOUNTING

*New England, New Jersey,
Delaware, Maryland, Virginia,
Eastern Pennsylvania, Midwest*

Misty Herrmann

Misty@empiredistributing.net
585-736-4053

KITCHEN SPECIALIST

Melissa Gordon

Mgordon@empiredistributing.net
585-492-2784

OUTDOOR HEAT SPECIALIST

Josh Wittmeyer

Josh@empiredistributing.net
585-736-4062

HOW TO ORDER

- **Online:** <https://weborders.empiredistributing.net/>
- **Email:** orders@empiredistributing.net
- **Fax:** (585) 492-2785
- **Phone:** (585) 492-2780

Placing your order Online ensures 100% accuracy and allows you to know what's in stock before you even place the order. You can set up your own account (all you need is your customer number located on your invoice) or contact our IT Department at it@empiredistributing.net or (585) 492-2780 for assistance.

To set-up an Empire account, please contact your local sales rep.